

NCS2530, NCS2530A

Triple 1.1 mA 200 MHz Current Feedback Op Amp with Enable Feature

NCS2530 is a triple 1.1 mA 200 MHz current feedback monolithic operational amplifier featuring high slew rate and low differential gain and phase error. The current feedback architecture allows for a superior bandwidth and low power consumption. This device features an enable pin.

Features

- -3.0 dB Small Signal BW ($A_V = +2.0$, $V_O = 0.5 V_{p-p}$) 200 MHz Typ
- Slew Rate 450 V/ μ s
- Supply Current 1.1 mA per amplifier
- Input Referred Voltage Noise 4.0 nV/ $\sqrt{\text{Hz}}$
- THD -55 dB ($f = 5.0$ MHz, $V_O = 2.0 V_{p-p}$)
- Output Current 100 mA
- Enable Pin Available
- These are Pb-Free Devices

Applications

- Portable Video
- Line Drivers
- Radar/Communication Receivers
- Set Top Box
- NTSC/PAL/HDTV

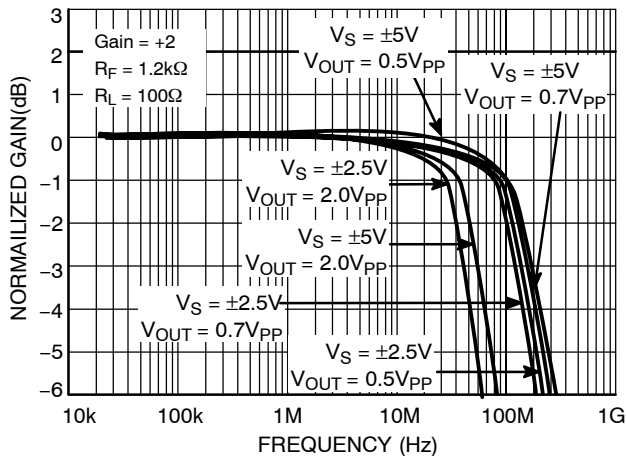
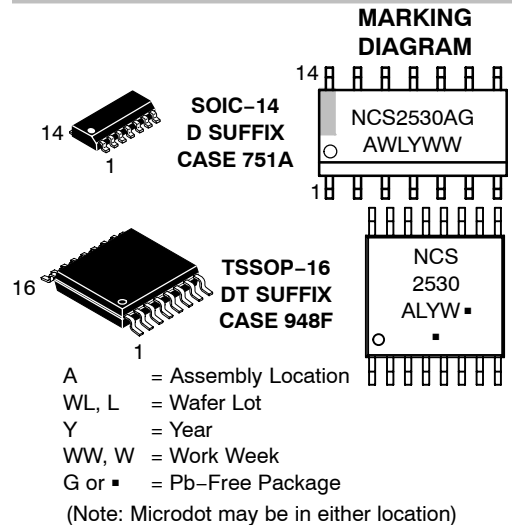

Figure 1. Frequency Response: Gain (dB) vs. Frequency $A_V = +2.0$, $R_L = 100 \Omega$



ON Semiconductor®

<http://onsemi.com>



SOIC-14 PINOUT (NCS2530A ONLY)

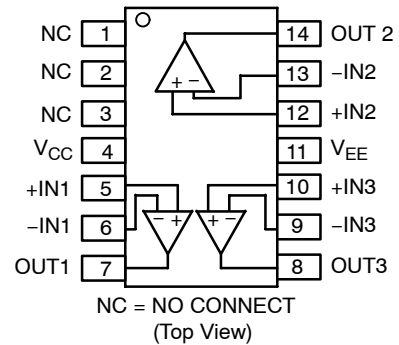

TSSOP-16 PINOUT (NCS2530 ONLY)

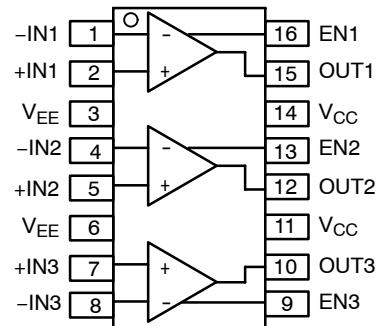

ORDERING INFORMATION

See detailed ordering and shipping information in the package dimensions section on page 13 of this data sheet.

NCS2530, NCS2530A

PIN FUNCTION DESCRIPTION

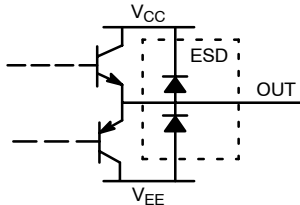
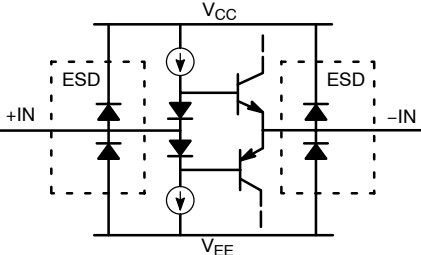
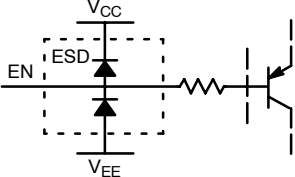
SOIC-14 (NCS2530A Only)	TSSOP-16 (NCS2530 Only)	Symbol	Function	Equivalent Circuit
7, 8, 14	10, 12, 15	OUTx	Output	
11	3, 6	V _{EE}	Negative Power Supply	
5, 10, 12	2, 5, 7	+INx	Non-inverted Input	
6, 9, 13	1, 4, 8	-INx	Inverted Input	See Above
4	11, 14	V _{CC}	Positive Power Supply	
N/A	9, 13, 16	EN	Enable	

ENABLE PIN TRUTH TABLE (NCS2530 Only)

	High*	Low
Enable	Enabled	Disabled

*Default open state

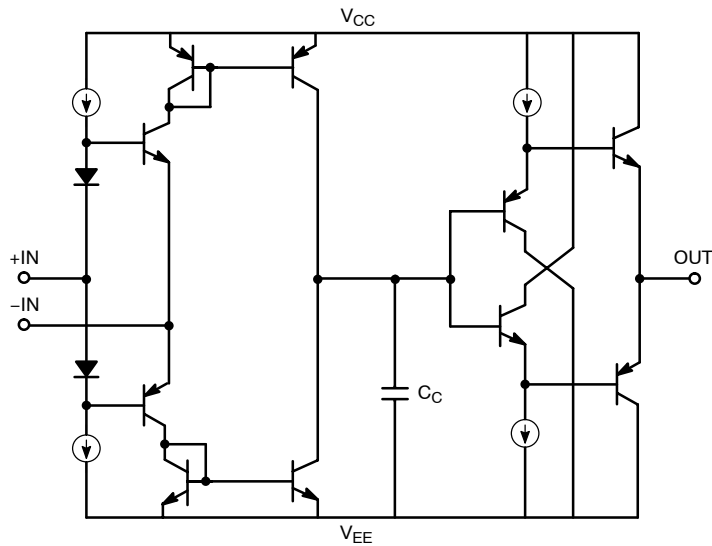

Figure 2. Simplified Device Schematic

NCS2530, NCS2530A

ATTRIBUTES

Characteristics	Value
ESD Human Body Model Machine Model Charged Device Model	2.0 kV (Note 1) 200 V 1.0 kV
Moisture Sensitivity (Note 2)	Level 1
Flammability Rating Oxygen Index: 28 to 34	UL 94 V-0 @ 0.125 in

- 0.8 kV between the input pairs +IN and -IN pins only. All other pins are 2.0 kV.
- For additional information, see Application Note AND8003/D.

MAXIMUM RATINGS

Parameter	Symbol	Rating	Unit
Power Supply Voltage	V_S	11	V_{DC}
Input Voltage Range	V_I	$\leq V_S$	V_{DC}
Input Differential Voltage Range	V_{ID}	$\leq V_S$	V_{DC}
Output Current	I_O	100	mA
Maximum Junction Temperature (Note 3)	T_J	150	$^{\circ}C$
Operating Ambient Temperature	T_A	-40 to +85	$^{\circ}C$
Storage Temperature Range	T_{stg}	-60 to +150	$^{\circ}C$
Power Dissipation	P_D	(See Graph)	mW
Thermal Resistance, Junction-to-Air	TSSOP-16 SOIC-14	$R_{\theta JA}$	$^{\circ}C/W$
		178 156	

Stresses exceeding Maximum Ratings may damage the device. Maximum Ratings are stress ratings only. Functional operation above the Recommended Operating Conditions is not implied. Extended exposure to stresses above the Recommended Operating Conditions may affect device reliability.

- Power dissipation must be considered to ensure maximum junction temperature (T_J) is not exceeded.

MAXIMUM POWER DISSIPATION

The maximum power that can be safely dissipated is limited by the associated rise in junction temperature. For the plastic packages, the maximum safe junction temperature is $150^{\circ}C$. If the maximum is exceeded momentarily, proper circuit operation will be restored as soon as the die temperature is reduced. Leaving the device in the “overheated” condition for an extended period can result in device damage.

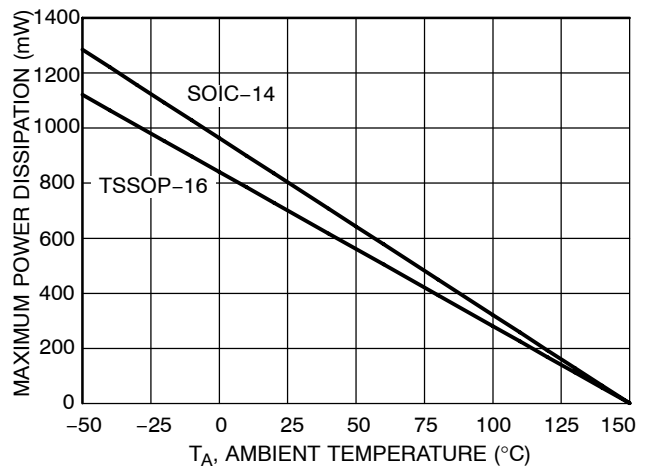

Figure 3. Power Dissipation vs. Temperature

NCS2530, NCS2530A

AC ELECTRICAL CHARACTERISTICS ($V_{CC} = +5.0\text{ V}$, $V_{EE} = -5.0\text{ V}$, $T_A = -40^\circ\text{C}$ to $+85^\circ\text{C}$, $R_L = 100\ \Omega$ to GND, $R_F = 1.2\text{ k}\Omega$, $A_V = +2.0$, Enable is left open, unless otherwise specified).

Symbol	Characteristic	Conditions	Min	Typ	Max	Unit
--------	----------------	------------	-----	-----	-----	------

FREQUENCY DOMAIN PERFORMANCE

BW	Bandwidth 3.0 dB Small Signal 3.0 dB Large Signal	$A_V = +2.0$, $V_O = 0.5\text{ V}_{p-p}$ $A_V = +2.0$, $V_O = 2.0\text{ V}_{p-p}$		200 140		MHz
GF _{0.1dB}	0.1 dB Gain Flatness Bandwidth	$A_V = +2.0$		30		MHz
dG	Differential Gain	$A_V = +2.0$, $R_L = 150\ \Omega$, $f = 3.58\text{ MHz}$		0.02		%
dP	Differential Phase	$A_V = +2.0$, $R_L = 150\ \Omega$, $f = 3.58\text{ MHz}$		0.1		°

TIME DOMAIN RESPONSE

SR	Slew Rate	$A_V = +2.0$, $V_{step} = 2.0\text{ V}$		450		V/ μs
t_s	Settling Time 0.01% 0.1%	$A_V = +2.0$, $V_{step} = 2.0\text{ V}$ $A_V = +2.0$, $V_{step} = 2.0\text{ V}$		35 18		ns
t_r , t_f	Rise and Fall Time	(10%–90%) $A_V = +2.0$, $V_{step} = 2.0\text{ V}$		5		ns
t_{ON}	Turn-on Time (Note 4)			900		ns
t_{OFF}	Turn-off Time (Note 4)			500		ns

HARMONIC/NOISE PERFORMANCE

THD	Total Harmonic Distortion	$f = 5.0\text{ MHz}$, $V_O = 2.0\text{ V}_{p-p}$, $R_L = 150\ \Omega$		-55		dBc
HD2	2nd Harmonic Distortion	$f = 5.0\text{ MHz}$, $V_O = 2.0\text{ V}_{p-p}$		-67		dBc
HD3	3rd Harmonic Distortion	$f = 5.0\text{ MHz}$, $V_O = 2.0\text{ V}_{p-p}$		-57		dBc
IP3	Third-Order Intercept	$f = 10\text{ MHz}$, $V_O = 2.0\text{ V}_{p-p}$		35		dBm
SFDR	Spurious-Free Dynamic Range	$f = 5.0\text{ MHz}$, $V_O = 2.0\text{ V}_{p-p}$		58		dBc
e_N	Input Referred Voltage Noise	$f = 1.0\text{ MHz}$		4		nV/ $\sqrt{\text{Hz}}$
i_N	Input Referred Current Noise	$f = 1.0\text{ MHz}$, Inverting $f = 1.0\text{ MHz}$, Non-Inverting		15 15		pA/ $\sqrt{\text{Hz}}$

4. Applies to NCS2530 device only.

NCS2530, NCS2530A

DC ELECTRICAL CHARACTERISTICS ($V_{CC} = +5.0\text{ V}$, $V_{EE} = -5.0\text{ V}$, $T_A = -40^\circ\text{C}$ to $+85^\circ\text{C}$, $R_L = 100\ \Omega$ to GND, $R_F = 1.2\text{ k}\Omega$, $A_V = +2.0$, Enable is left open, unless otherwise specified).

Symbol	Characteristic	Conditions	Min	Typ	Max	Unit
--------	----------------	------------	-----	-----	-----	------

DC PERFORMANCE

V_{IO}	Input Offset Voltage		-4.0	± 0.7	+4.0	mV
$\Delta V_{IO}/\Delta T$	Input Offset Voltage Temperature Coefficient			6.0		$\mu\text{V}/^\circ\text{C}$
I_{IB}	Input Bias Current	+Input (Non-Inverting), $V_O = 0\text{ V}$ -Input (Inverting), $V_O = 0\text{ V}$ (Note 5)	-5.0 -5.0	± 2.0 ± 0.4	+5.0 +5.0	μA
$\Delta I_{IB}/\Delta T$	Input Bias Current Temperature Coefficient	+Input (Non-Inverting), $V_O = 0\text{ V}$ -Input (Inverting), $V_O = 0\text{ V}$		± 40 ± 10		$\text{nA}/^\circ\text{C}$
V_{IH}	Input High Voltage (Enable) (Note 5 and 6)		$V_{CC} - 1.5\text{ V}$			V
V_{IL}	Input Low Voltage (Enable) (Note 5 and 6)				$V_{CC} - 3.5\text{ V}$	V

INPUT CHARACTERISTICS

V_{CM}	Input Common Mode Voltage Range (Note 5)		± 3.0	± 4.0		V
CMRR	Common Mode Rejection Ratio	(See Graph)	50	55		dB
R_{IN}	Input Resistance	+Input (Non-Inverting) -Input (Inverting)		4.0 350		$\text{M}\Omega$ Ω
C_{IN}	Differential Input Capacitance			1.0		pF

OUTPUT CHARACTERISTICS

R_{OUT}	Output Resistance	Closed Loop Open Loop		0.02 12		Ω
V_O	Output Voltage Swing		± 3.0	± 3.5		V
I_O	Output Current		± 60	± 100		mA

POWER SUPPLY

V_S	Operating Voltage Supply			10		V
$I_{S,ON}$	Power Supply Current – Enabled (per amplifier)	$V_O = 0\text{ V}$	0.6	1.1	2.0	mA
$I_{S,OFF}$	Power Supply Current – Disabled (per amplifier) (Note 6)	$V_O = 0\text{ V}$		0.35	0.5	mA
	Crosstalk	Channel to Channel, $f = 5.0\text{ MHz}$		60		dB
PSRR	Power Supply Rejection Ratio	(See Graph)	50	60		dB

5. Guaranteed by design and/or characterization.

6. Applies to NCS2530 device only.

NCS2530, NCS2530A

AC ELECTRICAL CHARACTERISTICS ($V_{CC} = +2.5\text{ V}$, $V_{EE} = -2.5\text{ V}$, $T_A = -40^\circ\text{C}$ to $+85^\circ\text{C}$, $R_L = 100\ \Omega$ to GND, $R_F = 1.2\text{ k}\Omega$, $A_V = +2.0$, Enable is left open, unless otherwise specified).

Symbol	Characteristic	Conditions	Min	Typ	Max	Unit
--------	----------------	------------	-----	-----	-----	------

FREQUENCY DOMAIN PERFORMANCE

BW	Bandwidth 3.0 dB Small Signal 3.0 dB Large Signal	$A_V = +2.0$, $V_O = 0.5\text{ V}_{p-p}$ $A_V = +2.0$, $V_O = 1.0\text{ V}_{p-p}$		180 130		MHz
GF _{0.1dB}	0.1 dB Gain Flatness Bandwidth	$A_V = +2.0$		15		MHz
dG	Differential Gain	$A_V = +2.0$, $R_L = 150\ \Omega$, $f = 3.58\text{ MHz}$		0.02		%
dP	Differential Phase	$A_V = +2.0$, $R_L = 150\ \Omega$, $f = 3.58\text{ MHz}$		0.1		°

TIME DOMAIN RESPONSE

SR	Slew Rate	$A_V = +2.0$, $V_{step} = 1.0\text{ V}$		350		V/ μs
t_s	Settling Time 0.01% 0.1%	$A_V = +2.0$, $V_{step} = 1.0\text{ V}$ $A_V = +2.0$, $V_{step} = 1.0\text{ V}$		40 18		ns
t_r , t_f	Rise and Fall Time	(10%–90%) $A_V = +2.0$, $V_{step} = 1.0\text{ V}$		8.0		ns
t_{ON}	Turn-on Time (Note 7)			900		ns
t_{OFF}	Turn-off Time (Note 7)			500		ns

HARMONIC/NOISE PERFORMANCE

THD	Total Harmonic Distortion	$f = 5.0\text{ MHz}$, $V_O = 1.0\text{ V}_{p-p}$, $R_L = 150\ \Omega$		-55		dBc
HD2	2nd Harmonic Distortion	$f = 5.0\text{ MHz}$, $V_O = 1.0\text{ V}_{p-p}$		-67		dBc
HD3	3rd Harmonic Distortion	$f = 5.0\text{ MHz}$, $V_O = 1.0\text{ V}_{p-p}$		-57		dBc
IP3	Third-Order Intercept	$f = 10\text{ MHz}$, $V_O = 1.0\text{ V}_{p-p}$		35		dBm
SFDR	Spurious-Free Dynamic Range	$f = 5.0\text{ MHz}$, $V_O = 1.0\text{ V}_{p-p}$		58		dBc
e_N	Input Referred Voltage Noise	$f = 1.0\text{ MHz}$		4.0		nV/ $\sqrt{\text{Hz}}$
i_N	Input Referred Current Noise	$f = 1.0\text{ MHz}$, Inverting $f = 1.0\text{ MHz}$, Non-Inverting		15 15		pA/ $\sqrt{\text{Hz}}$

7. Applies to NCS2530 device only.

NCS2530, NCS2530A

DC ELECTRICAL CHARACTERISTICS ($V_{CC} = +2.5\text{ V}$, $V_{EE} = -2.5\text{ V}$, $T_A = -40^\circ\text{C}$ to $+85^\circ\text{C}$, $R_L = 100\ \Omega$ to GND, $R_F = 1.2\text{ k}\Omega$, $A_V = +2.0$, Enable is left open, unless otherwise specified).

Symbol	Characteristic	Conditions	Min	Typ	Max	Unit
DC PERFORMANCE						
V_{IO}	Input Offset Voltage		-4.0	± 0.5	+4.0	mV
$\Delta V_{IO}/\Delta T$	Input Offset Voltage Temperature Coefficient			6.0		$\mu\text{V}/^\circ\text{C}$
I_{IB}	Input Bias Current	+Input (Non-Inverting), $V_O = 0\text{ V}$ -Input (Inverting), $V_O = 0\text{ V}$ (Note 8)	-5.0 -5.0	± 2.0 ± 0.4	+5.0 +5.0	μA
$\Delta I_{IB}/\Delta T$	Input Bias Current Temperature Coefficient	+Input (Non-Inverting), $V_O = 0\text{ V}$ -Input (Inverting), $V_O = 0\text{ V}$		± 40 ± 10		$\text{nA}/^\circ\text{C}$
V_{IH}	Input High Voltage (Enable) (Note 8 and 9)		$V_{CC} - 1.5\text{ V}$			V
V_{IL}	Input Low Voltage (Enable) (Note 8 and 9)				$V_{CC} - 3.5\text{ V}$	V

INPUT CHARACTERISTICS

V_{CM}	Input Common Mode Voltage Range (Note 8)		± 1.3	± 1.5		V
CMRR	Common Mode Rejection Ratio	(See Graph)	50	55		dB
R_{IN}	Input Resistance	+Input (Non-Inverting) -Input (Inverting)		4.0 350		$\text{M}\Omega$ Ω
C_{IN}	Differential Input Capacitance			1.0		pF

OUTPUT CHARACTERISTICS

R_{OUT}	Output Resistance	Closed Loop Open Loop		0.02 12		Ω
V_O	Output Voltage Swing		± 1.0	± 1.4		V
I_O	Output Current		± 40	± 80		mA

POWER SUPPLY

V_S	Operating Voltage Supply			5.0		V
$I_{S,ON}$	Power Supply Current – Enabled (per amplifier)	$V_O = 0\text{ V}$	0.5	0.9	1.9	mA
$I_{S,OFF}$	Power Supply Current – Disabled (per amplifier) (Note 9)	$V_O = 0\text{ V}$		0.15	0.35	mA
	Crosstalk	Channel to Channel, $f = 5.0\text{ MHz}$		60		mA
PSRR	Power Supply Rejection Ratio	(See Graph)	50	60		dB

8. Guaranteed by design and/or characterization.
9. Applies to NCS2530 device only.

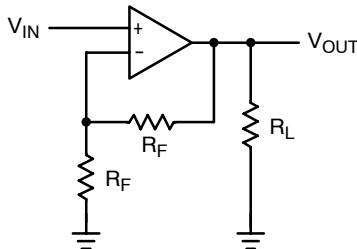

Figure 4. Typical Test Setup
($A_V = +2.0$, $R_F = 1.8\text{ k}\Omega$ or $1.2\text{ k}\Omega$ or $1.0\text{ k}\Omega$, $R_L = 100\ \Omega$)

NCS2530, NCS2530A

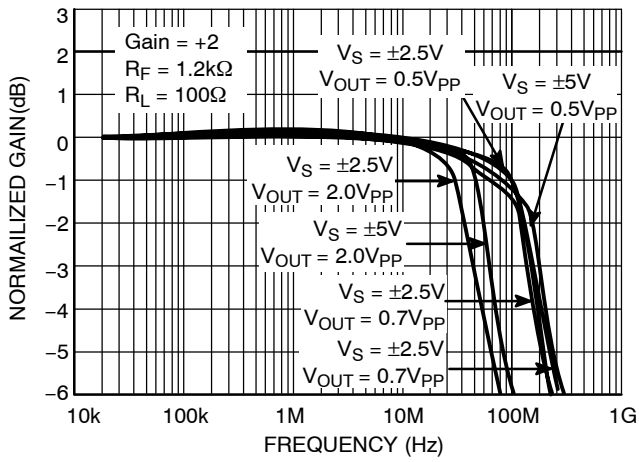

Figure 5. Frequency Response:
Gain (dB) vs. Frequency
 $A_v = +2.0$

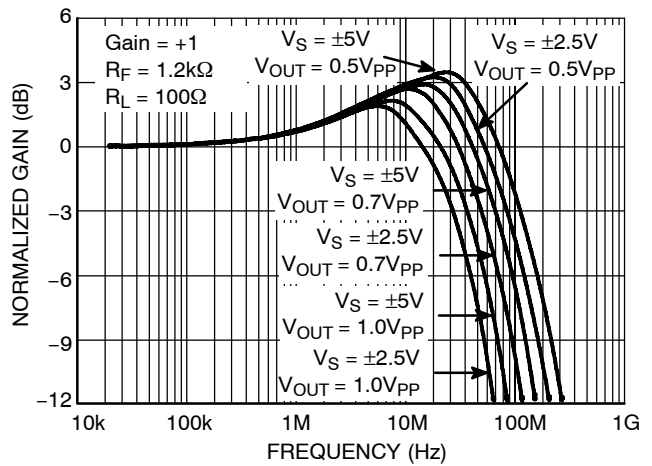

Figure 6. Frequency Response:
Gain (dB) vs. Frequency
 $A_v = +1.0$

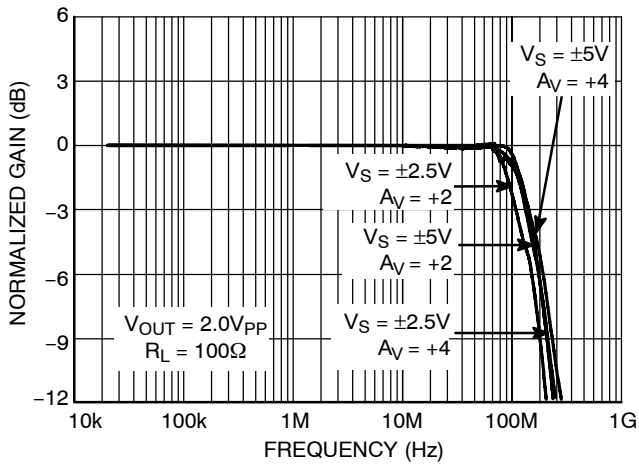

Figure 7. Large Signal Frequency Response
Gain (dB) vs. Frequency

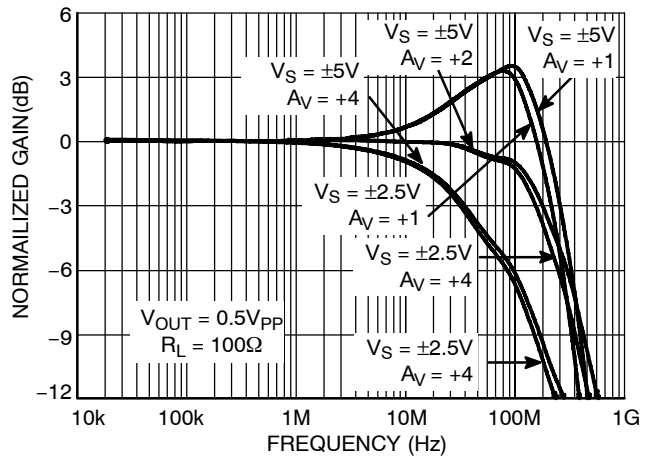

Figure 8. Small Signal Frequency Response
Gain (dB) vs. Frequency

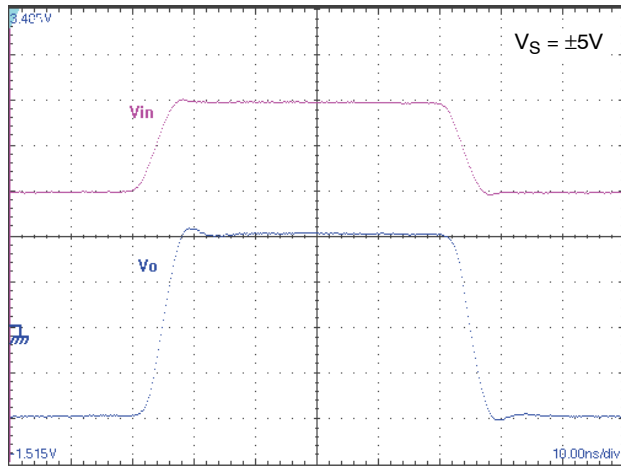

Figure 9. Small Signal Step Response
Vertical: 500 mV/div
Horizontal: 10 ns/div

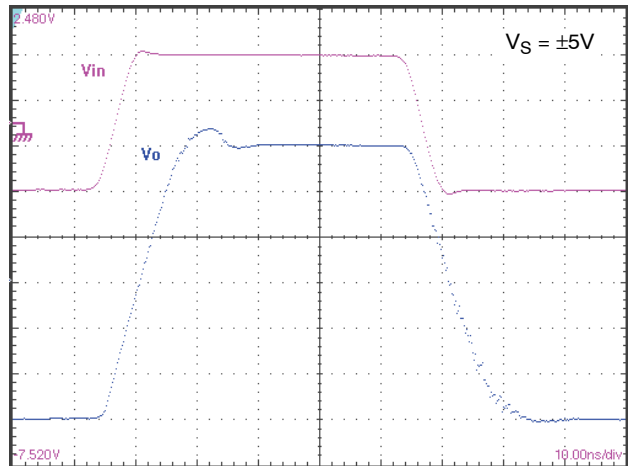

Figure 10. Large Signal Step Response
Vertical: 500 mV/div
Horizontal: 10 ns/div

NCS2530, NCS2530A

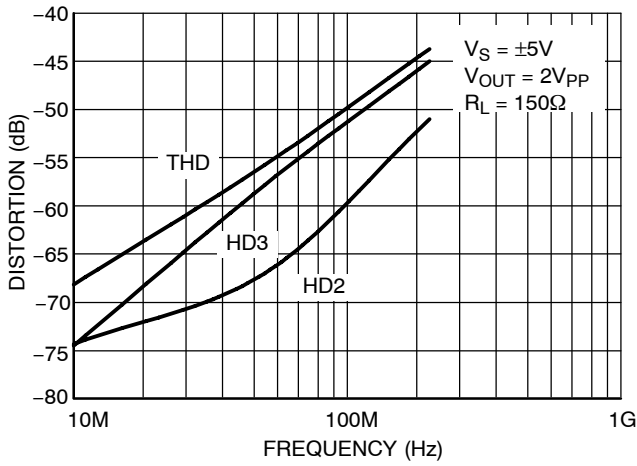

Figure 11. THD, HD2, HD3 vs. Frequency

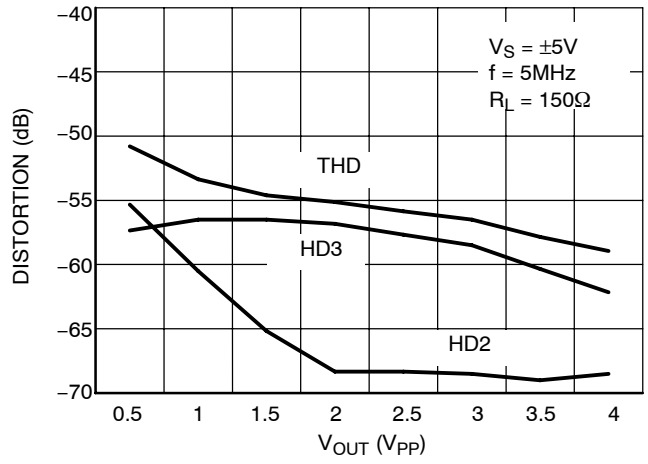

Figure 12. THD, HD2, HD3 vs. Output Voltage

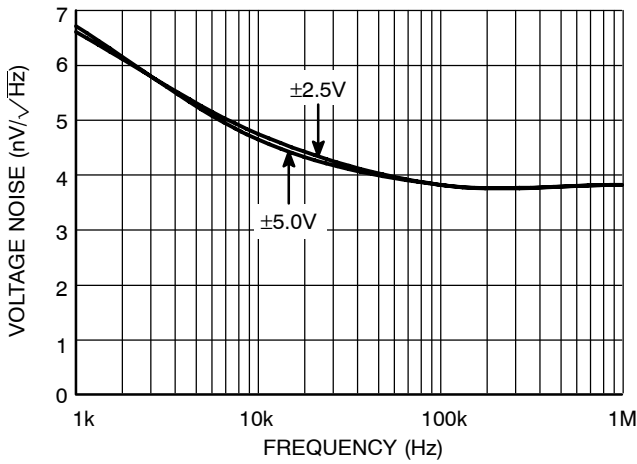

Figure 13. Input Referred Noise vs. Frequency

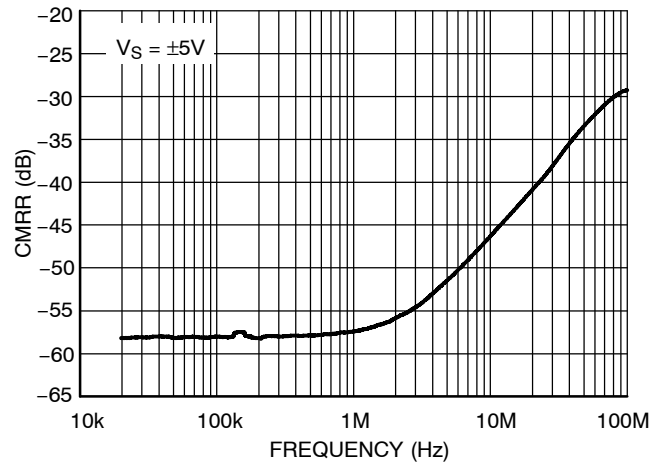

Figure 14. CMRR vs. Frequency

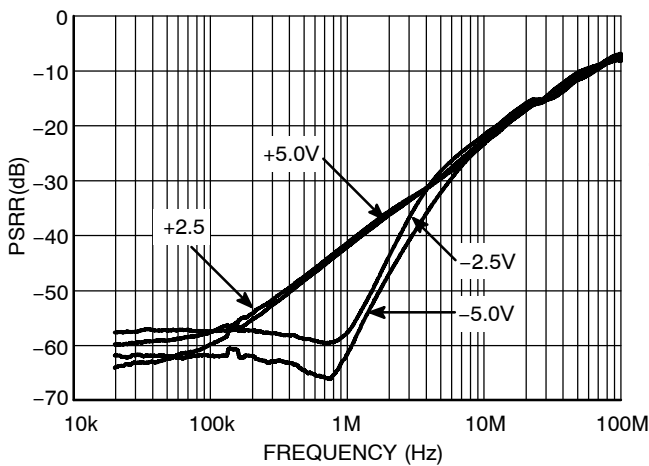

Figure 15. PSRR vs. Frequency

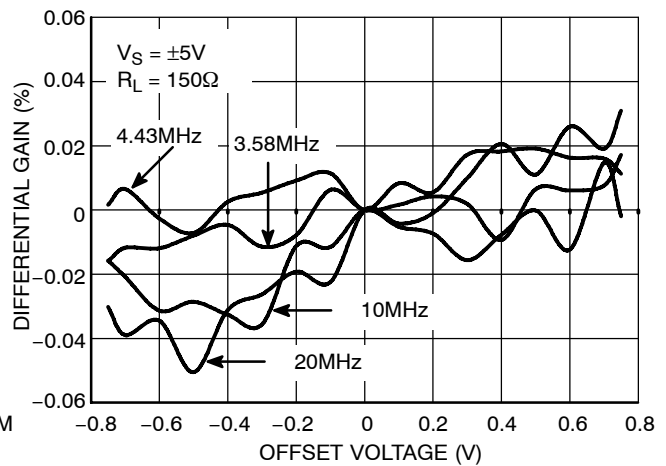

Figure 16. Differential Gain

NCS2530, NCS2530A

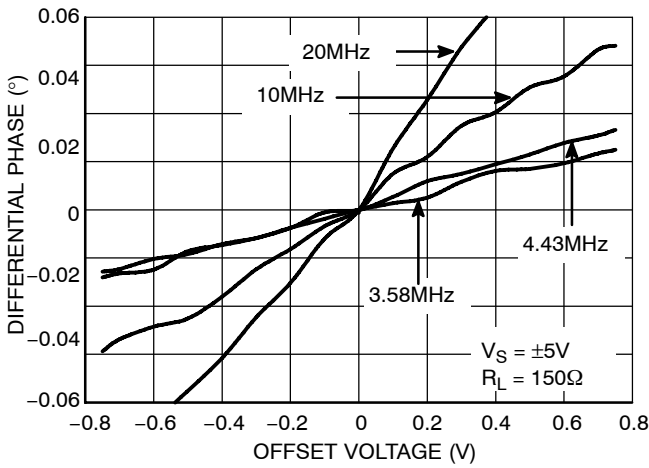

Figure 17. Differential Phase

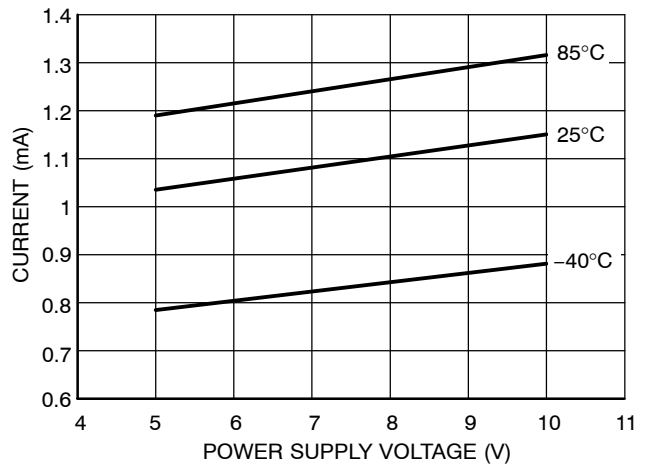

Figure 18. Supply Current per Amplifier vs. Power Supply vs. Temperature (Enabled)

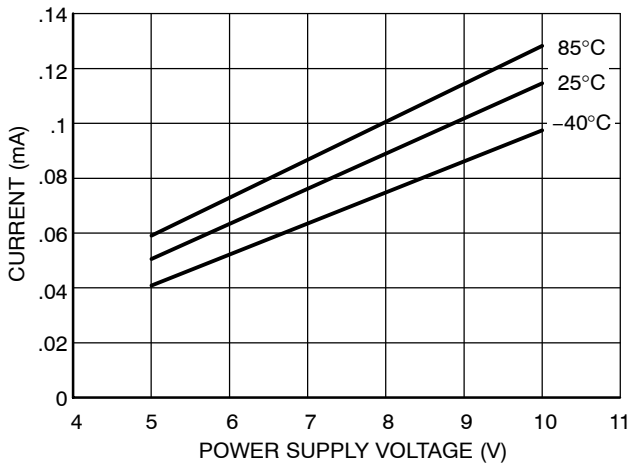

Figure 19. Supply Current per Amplifier vs. Power Supply vs. Temperature (Disabled)
(NCS2530 Only)

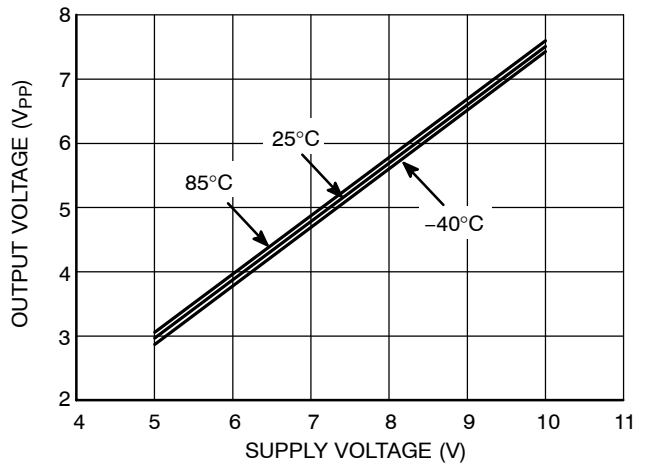

Figure 20. Output Voltage Swing vs. Supply Voltage

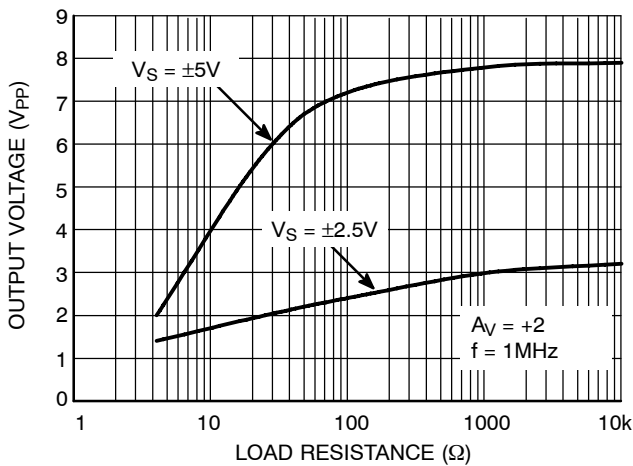

Figure 21. Output Voltage Swing vs. Load Resistance

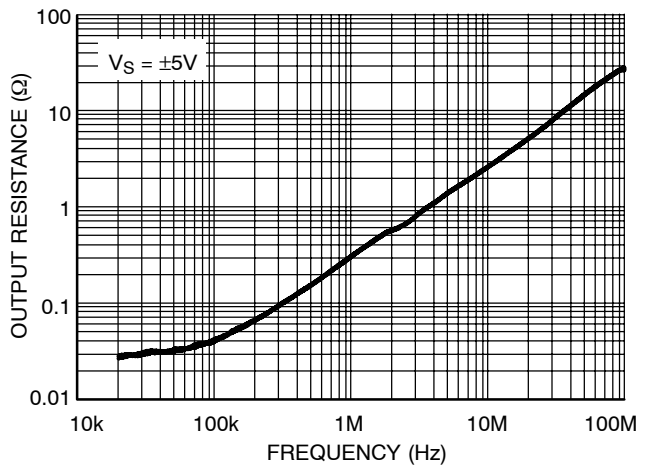

Figure 22. Output Impedance vs. Frequency

NCS2530, NCS2530A

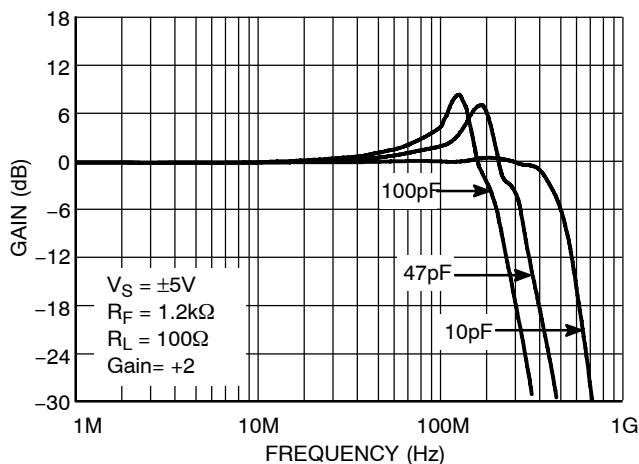

Figure 23. Frequency Response vs. Capacitive Load

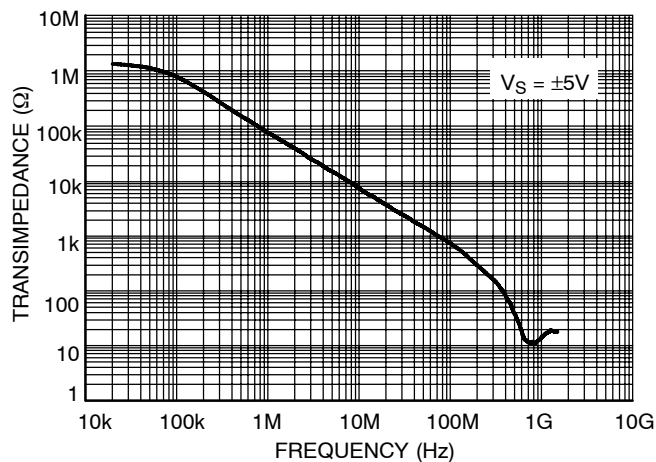

Figure 24. Transimpedance (ROL) vs. Frequency

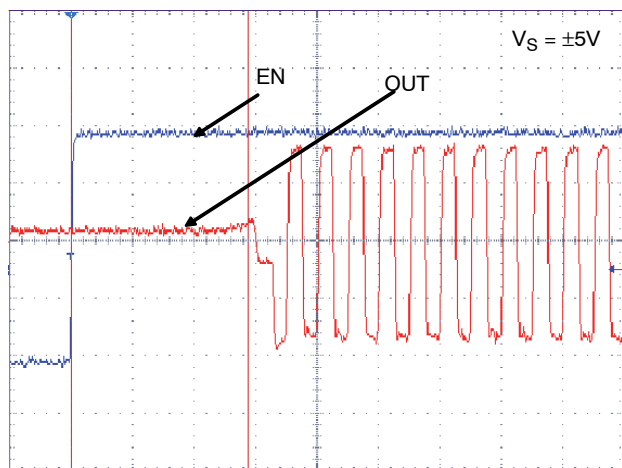

Figure 25. Turn ON Time Delay
Vertical: 10 mV/Div, Horizontal: 4 ns/Div
(Output Signal: Square Wave, 10 MHz, 2 V_{pp})
(NCS2530 Only)

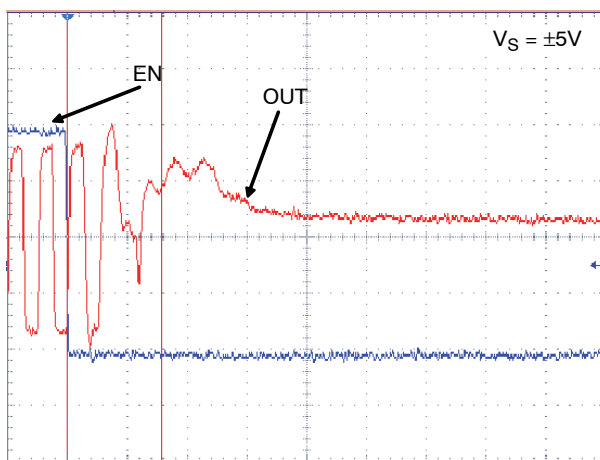

Figure 26. Turn OFF Time Delay
Vertical: 10 mV/Div, Horizontal: 4 ns/Div
(Output Signal: Square Wave, 10 MHz, 2 V_{pp})
(NCS2530 Only)

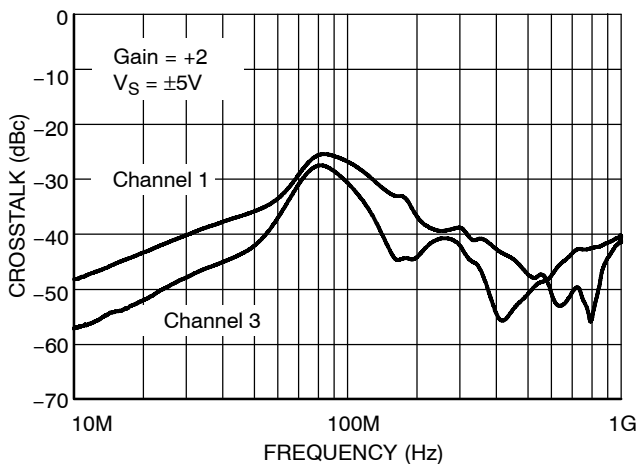

Figure 27. Crosstalk (dBc) vs. Frequency
(Crosstalk measured on Channel 2 with input signal on Channel 1 and 3)

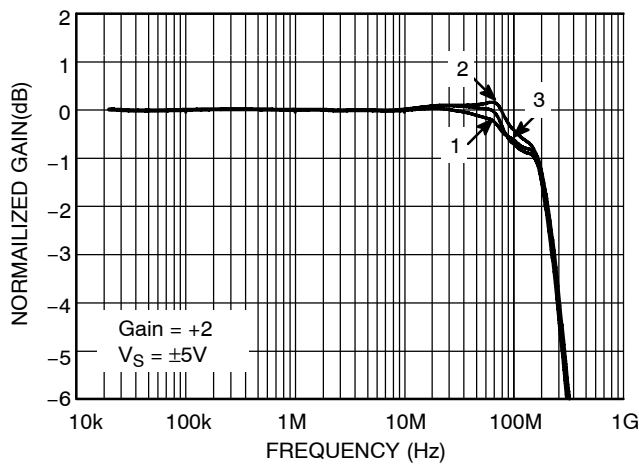

Figure 28. Channel Matching Gain (dB) vs. Frequency

General Design Considerations

The current feedback amplifier is optimized for use in high performance video and data acquisition systems. For current feedback architecture, its closed-loop bandwidth depends on the value of the feedback resistor. The closed-loop bandwidth is not a strong function of gain, as is for a voltage feedback amplifier, as shown in Figure 29.

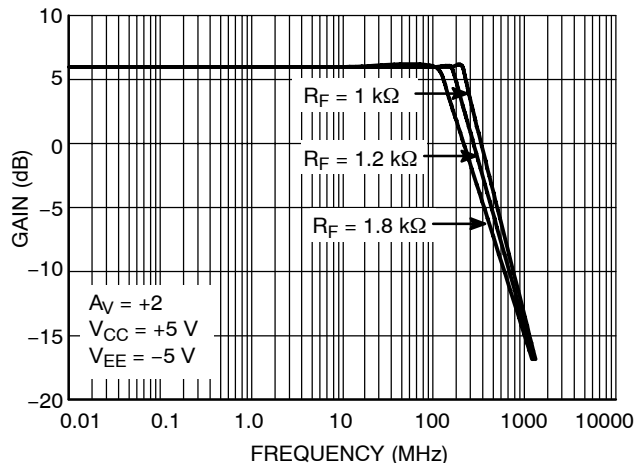

Figure 29. Frequency Response vs. R_F

The -3.0 dB bandwidth is, to some extent, dependent on the power supply voltages. By using lower power supplies, the bandwidth is reduced, because the internal capacitance increases. Smaller values of feedback resistor can be used at lower supply voltages, to compensate for this affect.

Feedback and Gain Resistor Selection for Optimum Frequency Response

A current feedback operational amplifier’s key advantage is the ability to maintain optimum frequency response independent of gain by using appropriate values for the feedback resistor. To obtain a very flat gain response, the feedback resistor tolerance should be considered as well. Resistor tolerance of 1% should be used for optimum flatness. Normally, lowering R_F resistor from its recommended value will peak the frequency response and extend the bandwidth while increasing the value of R_F resistor will cause the frequency response to roll off faster. Reducing the value of R_F resistor too far below its recommended value will cause overshoot, ringing, and eventually oscillation.

Since each application is slightly different, it is worth some experimentation to find the optimal R_F for a given circuit. A value of the feedback resistor that produces ~ 0.1 dB of peaking is the best compromise between stability and maximal bandwidth. It is not recommended to use a current feedback amplifier with the output shorted directly to the inverting input.

Printed Circuit Board Layout Techniques

Proper high speed PCB design rules should be used for all wideband amplifiers as the PCB parasitics can affect the overall performance. Most important are stray capacitances at the output and inverting input nodes as it can effect peaking and bandwidth. A space (3/16" is plenty) should be left around the signal lines to minimize coupling. Also, signal lines connecting the feedback and gain resistors should be short enough so that their associated inductance does not cause high frequency gain errors. Line lengths less than 1/4" are recommended.

Video Performance

This device designed to provide good performance with NTSC, PAL, and HDTV video signals. Best performance is obtained with back terminated loads as performance is degraded as the load is increased. The back termination reduces reflections from the transmission line and effectively masks transmission line and other parasitic capacitances from the amplifier output stage.

Video Line Driver

NCS2530 can be used in video line driver applications. Figure 30 shows a typical schematic for a video driver. In some applications, two or more video loads have to be driven simultaneously as shown in Figure 31. Figure 32 shows the typical performance of the op amp with single and triple video load.

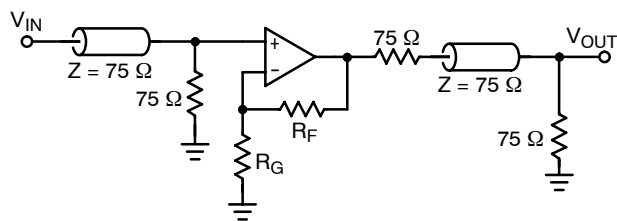

Figure 30. Video Driver Schematic

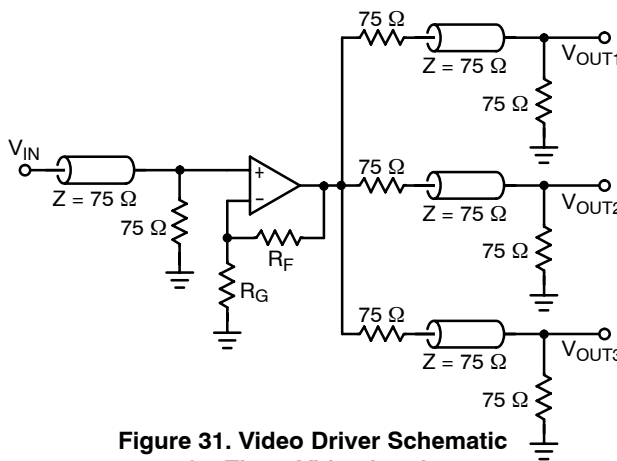

Figure 31. Video Driver Schematic for Three Video Loads

NCS2530, NCS2530A

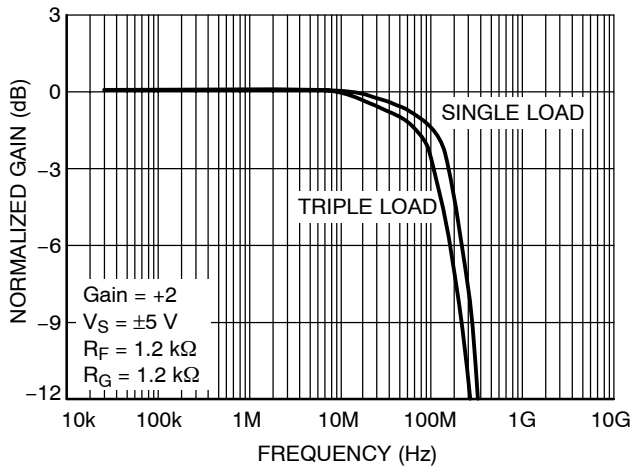

Figure 32. Frequency Response with Various Loads

ESD Protection

All device pins have limited ESD protection using internal diodes to power supplies as specified in the attributes table (See Figure 33). These diodes provide moderate protection to input overdrive voltages above the supplies. The ESD diodes can support high input currents with current limiting

series resistors. Keep these resistor values as low as possible since high values degrade both noise performance and frequency response. Under closed-loop operation, the ESD diodes have no effect on circuit performance. However, under certain conditions the ESD diodes will be evident. If the device is driven into a slewing condition, the ESD diodes will clamp large differential voltages until the feedback loop restores closed-loop operation. Also, if the device is powered down and a large input signal is applied, the ESD diodes will conduct.

Note: Human Body Model for +IN and -IN pins are rated at 0.8 kV while all other pins are rated at 2.0 kV.

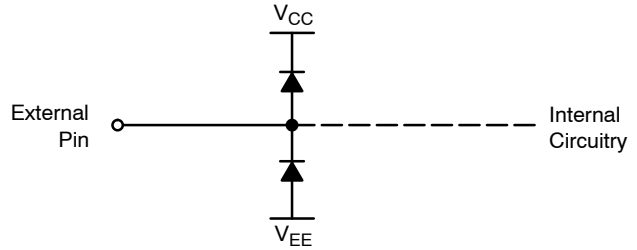

Figure 33. Internal ESD Protection

ORDERING INFORMATION

Device	Package	Shipping [†]
NCS2530ADG	SOIC-14 (Pb-Free)	55 Units / Rail
NCS2530ADR2G	SOIC-14 (Pb-Free)	2500 / Tape & Reel
NCS2530DTBG	TSSOP-16*	96 Units / Rail
NCS2530DTBR2G	TSSOP-16*	2500 / Tape & Reel

[†]For information on tape and reel specifications, including part orientation and tape sizes, please refer to our Tape and Reel Packaging Specifications Brochure, BRD8011/D.

*This package is inherently Pb-Free.

NCS2530, NCS2530A

PACKAGE DIMENSIONS

SOIC-14
CASE 751A-03
ISSUE H

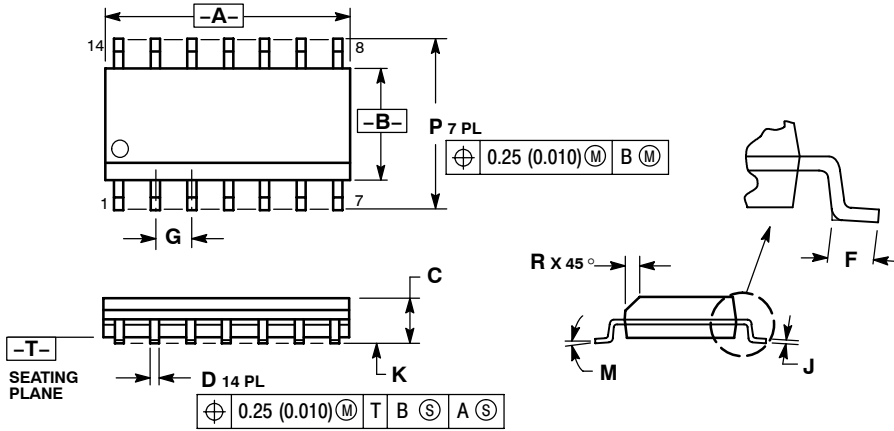

NOTES:

1. DIMENSIONING AND TOLERANCING PER ANSI Y14.5M, 1982.
2. CONTROLLING DIMENSION: MILLIMETER.
3. DIMENSIONS A AND B DO NOT INCLUDE MOLD PROTRUSION.
4. MAXIMUM MOLD PROTRUSION 0.15 (0.006) PER SIDE.
5. DIMENSION D DOES NOT INCLUDE DAMBAR PROTRUSION. ALLOWABLE DAMBAR PROTRUSION SHALL BE 0.127 (0.005) TOTAL IN EXCESS OF THE D DIMENSION AT MAXIMUM MATERIAL CONDITION.

DIM	MILLIMETERS		INCHES	
	MIN	MAX	MIN	MAX
A	8.55	8.75	0.337	0.344
B	3.80	4.00	0.150	0.157
C	1.35	1.75	0.054	0.068
D	0.35	0.49	0.014	0.019
F	0.40	1.25	0.016	0.049
G	1.27 BSC		0.050 BSC	
J	0.19	0.25	0.008	0.009
K	0.10	0.25	0.004	0.009
M	0° 7°		0° 7°	
P	5.80	6.20	0.228	0.244
R	0.25	0.50	0.010	0.019

SOLDERING FOOTPRINT*

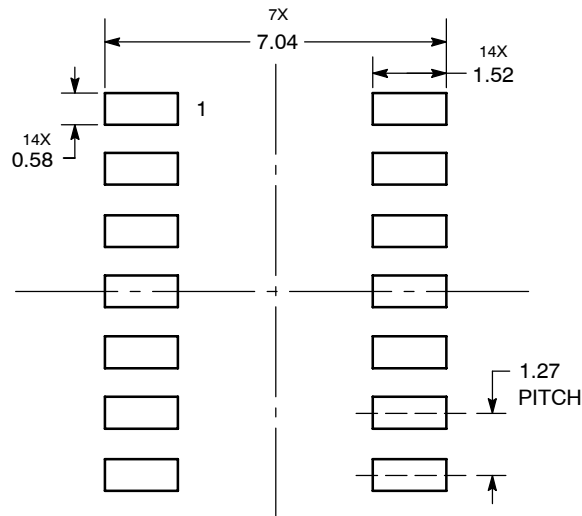

DIMENSIONS: MILLIMETERS

*For additional information on our Pb-Free strategy and soldering details, please download the ON Semiconductor Soldering and Mounting Techniques Reference Manual, SOLDERRM/D.

NCS2530, NCS2530A

PACKAGE DIMENSIONS

TSSOP-16
CASE 948F-01
ISSUE B

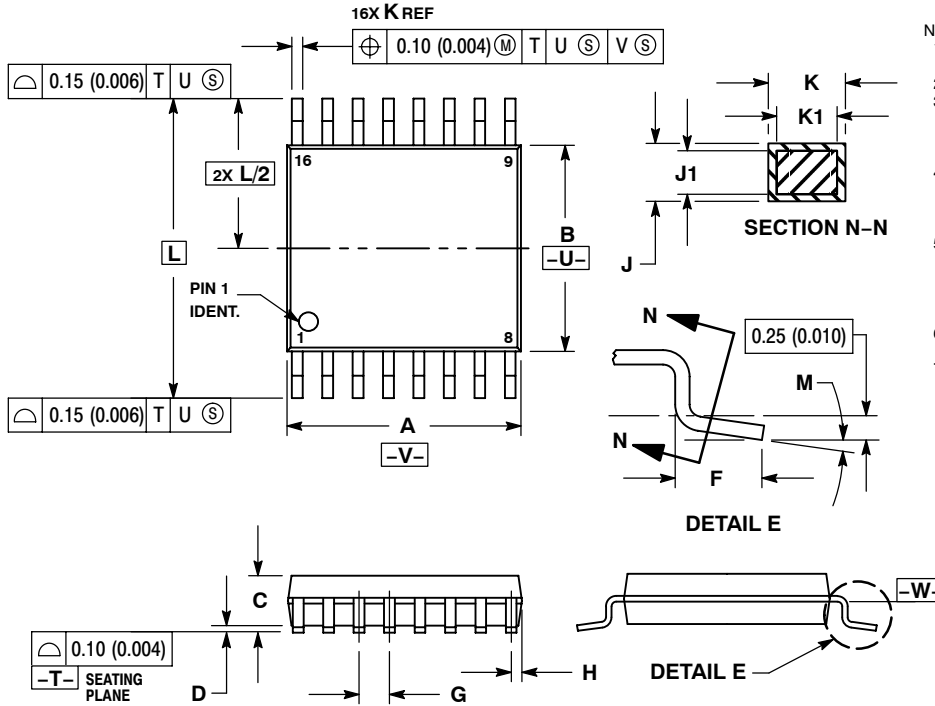

NOTES:

1. DIMENSIONING AND TOLERANCING PER ANSI Y14.5M, 1982.
2. CONTROLLING DIMENSION: MILLIMETER.
3. DIMENSION A DOES NOT INCLUDE MOLD FLASH, PROTRUSIONS OR GATE BURRS. MOLD FLASH OR GATE BURRS SHALL NOT EXCEED 0.15 (0.006) PER SIDE.
4. DIMENSION B DOES NOT INCLUDE INTERLEAD FLASH OR PROTRUSION. INTERLEAD FLASH OR PROTRUSION SHALL NOT EXCEED 0.25 (0.010) PER SIDE.
5. DIMENSION K DOES NOT INCLUDE DAMBAR PROTRUSION. ALLOWABLE DAMBAR PROTRUSION SHALL BE 0.08 (0.003) TOTAL IN EXCESS OF THE K DIMENSION AT MAXIMUM MATERIAL CONDITION.
6. TERMINAL NUMBERS ARE SHOWN FOR REFERENCE ONLY.
7. DIMENSION A AND B ARE TO BE DETERMINED AT DATUM PLANE -W-.

DIM	MILLIMETERS		INCHES	
	MIN	MAX	MIN	MAX
A	4.90	5.10	0.193	0.200
B	4.30	4.50	0.169	0.177
C	---	1.20	---	0.047
D	0.05	0.15	0.002	0.006
F	0.50	0.75	0.020	0.030
G	0.65 BSC		0.026 BSC	
H	0.18	0.28	0.007	0.011
J	0.09	0.20	0.004	0.008
J1	0.09	0.16	0.004	0.006
K	0.19	0.30	0.007	0.012
K1	0.19	0.25	0.007	0.010
L	6.40 BSC		0.252 BSC	
M	0°	8°	0°	8°

SOLDERING FOOTPRINT*

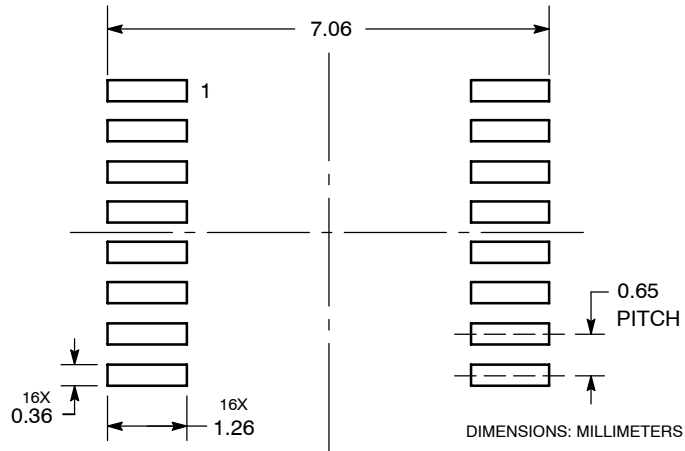

*For additional information on our Pb-Free strategy and soldering details, please download the ON Semiconductor Soldering and Mounting Techniques Reference Manual, SOLDERRM/D.

NCS2530, NCS2530A

ON Semiconductor and  are registered trademarks of Semiconductor Components Industries, LLC (SCILLC). SCILLC reserves the right to make changes without further notice to any products herein. SCILLC makes no warranty, representation or guarantee regarding the suitability of its products for any particular purpose, nor does SCILLC assume any liability arising out of the application or use of any product or circuit, and specifically disclaims any and all liability, including without limitation special, consequential or incidental damages. "Typical" parameters which may be provided in SCILLC data sheets and/or specifications can and do vary in different applications and actual performance may vary over time. All operating parameters, including "Typicals" must be validated for each customer application by customer's technical experts. SCILLC does not convey any license under its patent rights nor the rights of others. SCILLC products are not designed, intended, or authorized for use as components in systems intended for surgical implant into the body, or other applications intended to support or sustain life, or for any other application in which the failure of the SCILLC product could create a situation where personal injury or death may occur. Should Buyer purchase or use SCILLC products for any such unintended or unauthorized application, Buyer shall indemnify and hold SCILLC and its officers, employees, subsidiaries, affiliates, and distributors harmless against all claims, costs, damages, and expenses, and reasonable attorney fees arising out of, directly or indirectly, any claim of personal injury or death associated with such unintended or unauthorized use, even if such claim alleges that SCILLC was negligent regarding the design or manufacture of the part. SCILLC is an Equal Opportunity/Affirmative Action Employer. This literature is subject to all applicable copyright laws and is not for resale in any manner.

PUBLICATION ORDERING INFORMATION

LITERATURE FULFILLMENT:

Literature Distribution Center for ON Semiconductor
P.O. Box 5163, Denver, Colorado 80217 USA
Phone: 303-675-2175 or 800-344-3860 Toll Free USA/Canada
Fax: 303-675-2176 or 800-344-3867 Toll Free USA/Canada
Email: orderlit@onsemi.com

N. American Technical Support: 800-282-9855 Toll Free
USA/Canada
Europe, Middle East and Africa Technical Support:
Phone: 421 33 790 2910
Japan Customer Focus Center
Phone: 81-3-5773-3850

ON Semiconductor Website: www.onsemi.com
Order Literature: <http://www.onsemi.com/orderlit>

For additional information, please contact your local
Sales Representative